

CHILDREN'S ELECTRONIC TOY MOTORCYCLE INSTALLATION AND OPERATION MANUAL



1. Suitable age for 18-36 Months.
2. Maximum user weight: 20KGS.
3. Adult assembly required

OWNER'S MANUAL

with Assembly Instructions

Read and understand this entire manual before using!

**Please keep this manual for future reference as it contains
important information.**

Before first time use, charge the battery for at least 8-12 hours.

About Your New Vehicle

Specification





Item	Specifications
Battery	6V4.5AH
Motor	380#
Maximum weight	20KGS
Size	73*39*50CM
Speed	3Km/h
Using time	working for 1-2 hours, once charged for 8-12 hours
Available ages	Children at 18-36 months
Charger	DC6V500mA







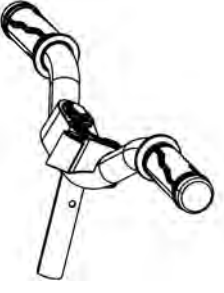



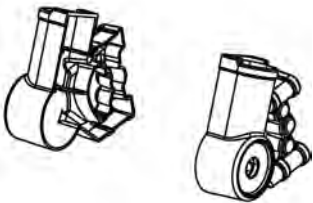

Disposal Of Battery

1. Your sealed lead-acid battery must be recycled or disposed of in an environmentally sound manner.
2. Do not dispose of your lead-acid battery in a fire. The battery may explode or leak
3. Do not dispose of a lead-acid battery in your regular, household trash. The incineration, land filling or mixing of sealed lead-acid batteries with household trash is prohibited by law.



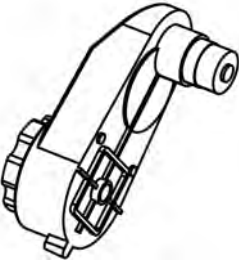

Our products are suitable for ASTM F963; CPSIA; EN71 and EN62115 standard.

Parts Diagram

			
1. Body	2. Windshield	3. Handlerbar	4. Fork

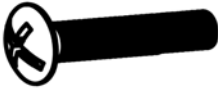
			
5. Front fork decoration	6. Front mud plate	7. Tap sleeve	8. Front axle
			
9. A rear axle	10. Front wheel	11. Rear wheel X2	12. Axle sleeve
			
13. Motor	14. Charger	15. Antenna	16. Hold-all X2

Number of screw packs

1 	2 	3 	4 
5 			
1. 10MM GASKET X6		4. M5 CHECK BACK NUT X1	
2. 2.5X30 SCREW X1		5. 4X10 SCREW X6	
3. M8 CHECK BACK NUT X4			

Attach the Side Wheels & Rear Fender

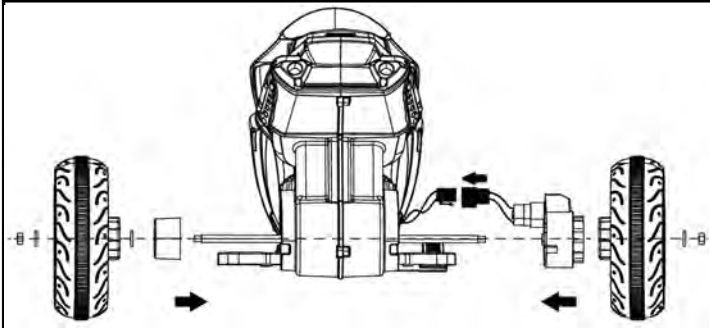

1. insert the back axis, assemble the gear motor & Axle sleeve, CONNECT THE MOTOR ELECTRIC LINE INTO THE MOTOR, assemble back wheels, fix the wheels(2XM8 NUT&3X10MM GASKET)

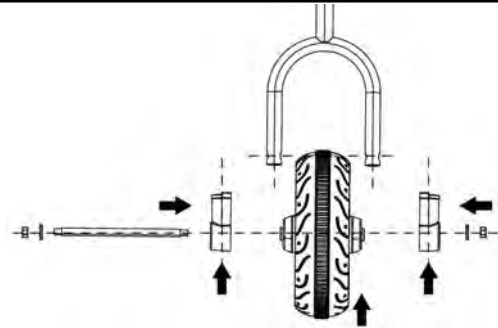

2.insert the frok decoration into the fork, insert the front axle&fix the front wheel (2XM8 NUT&2X10MM GASKET)

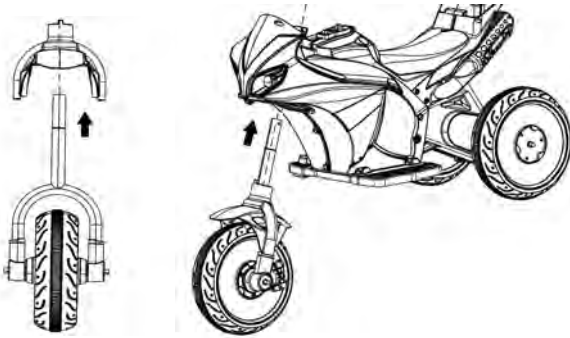

3.insert Front mud plate onto the fork,Lift the body and insert the steering tube

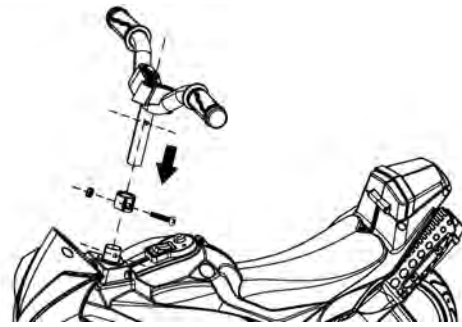

5.fix the handle bar&tap sleeve (1X(5X30)SCREW&1XM5 NUT)



6.Stuck the windshield on car.

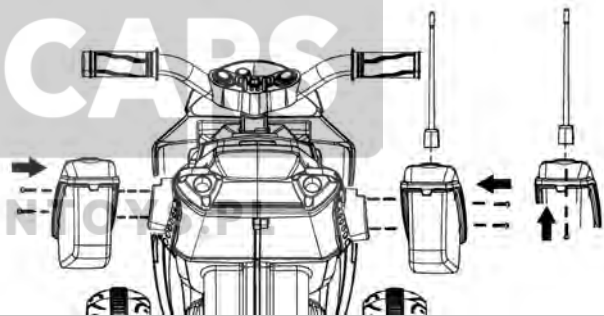

Attach the antenna (1X(4X10)SCREW) to the toolbox cover and fix the toolbox (4X(4X10)SCREW) onto the exhaust pipe

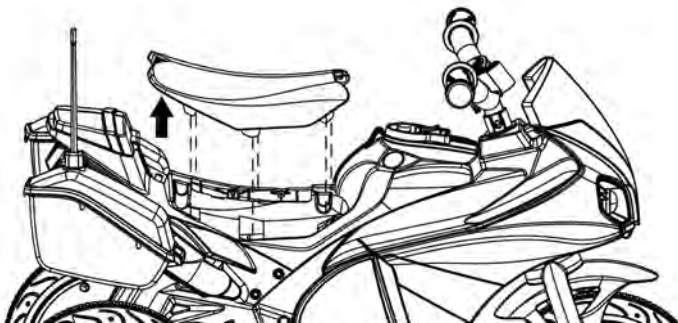

7.Loosen the 4x10 mounting screws and open the seat cushion

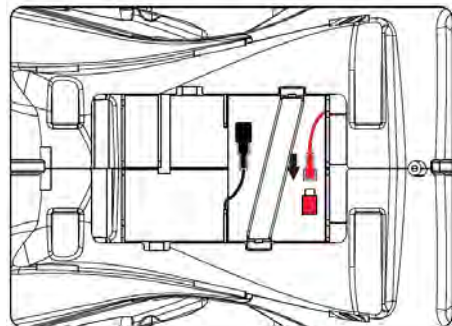

8.CONNECT THE BATTERY ELECTRIC LINE INTO THE BATTERY